



NOTES:

1. ALL THE LENGTH OF OUTPUT WIRES EXCLUDE HOUSING.
2. Label of origin is marked if indicated by sales.
3. DIMENSIONAL TOLERANCES: .XX=±0.5 [0.02]、.XXX=±0.25 [0.01].
4. Cable used UL2468 black cable(P1~P13、A~O).  
Cable used SOFT軟線80P UL1569 black cable(16AWG:P14~P15).  
Cable used UL2651 black cable(24AWG:P14~P15).  
(Color of CONNECTOR: Black)

P/N.:9PA8508500

MODEL NO. :FSP850-57AGC,(STD0001)		TITLE:ASSY	SHEET: 1 OF 2	REV:01
R&D 8	PE	DRAWN	DATE	
		JAN.26.2024		
 				

UNIT:mm [inch]

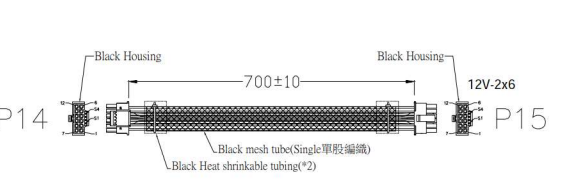
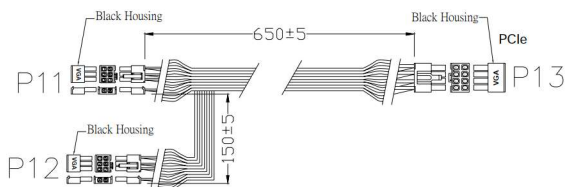
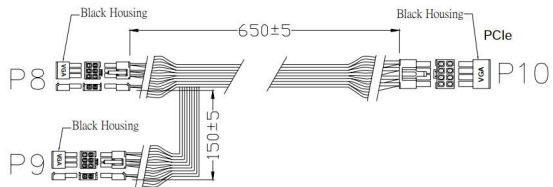
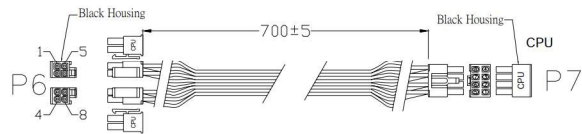
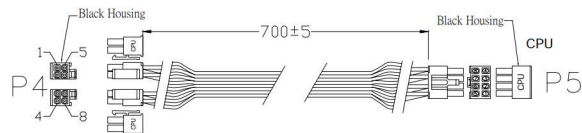
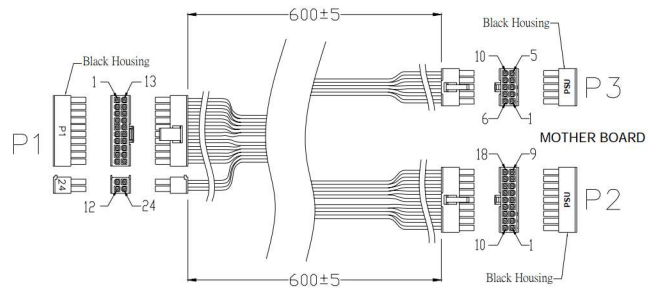

P1 P20-42002K110-B P4-42002K110-B OR EQU.	RATING	WIRE COLOR	WIRE AWG	P2 P18-42002-B5 OR EQU.	P3 P10-42002-B3 OR EQU.
Pin 1	+3.3V	BLACK	18 AWG	Pin 1	Pin 1
Pin 2	+3.3V	BLACK	18 AWG	Pin 2	Pin 2
Pin 3	+3.3V Sense	BLACK	22 AWG	Pin 8	Pin 5
Pin 4	COM	BLACK	18 AWG	Pin 5	Pin 8
Pin 5	+5V	BLACK	18 AWG	Pin 6	Pin 5
Pin 6	+5V	BLACK	18 AWG	Pin 3	Pin 5
Pin 7	+5V Sense	BLACK	22 AWG	Pin 10	Pin 10
Pin 8	COM	BLACK	18 AWG	Pin 10	Pin 10
Pin 9	PW_OK	BLACK	22 AWG	Pin 11	Pin 7
Pin 10	+5Veb	BLACK	18 AWG	Pin 4	Pin 7
Pin 11	+12V	BLACK	18 AWG	Pin 4	Pin 8
Pin 12	+12V Sense	BLACK	22 AWG	Pin 3	Pin 8
Pin 13	+3.3V	BLACK	18 AWG	Pin 10	Pin 3
Pin 14	+3.3V	BLACK	18 AWG	Pin 6	Pin 6
Pin 15	-12V	BLACK	18 AWG	Pin 9	Pin 9
Pin 16	COM	BLACK	18 AWG	Pin 9	Pin 9
Pin 17	PS_ON#	BLACK	22 AWG	Pin 1	Pin 1
Pin 18	COM	BLACK	18 AWG	Pin 12	Pin 12
Pin 19	COM	BLACK	18 AWG	Pin 16	Pin 16
Pin 20	COM	BLACK	18 AWG	Pin 17	Pin 17
Pin 21	+5V	BLACK	18 AWG	Pin 7	Pin 7
Pin 22	+5V	BLACK	18 AWG	Pin 14	Pin 14
Pin 23	+5V	BLACK	18 AWG	Pin 15	Pin 15
Pin 24	COM	BLACK	18 AWG	Pin 18	Pin 18

P4&P6 P4-42002K48-B4 OR EQU.	RATING	WIRE COLOR	WIRE AWG	P5&P7 P8-42002-B4 OR EQU.
Pin 1	COM	BLACK	16 AWG	Pin 1
Pin 2	COM	BLACK	16 AWG	Pin 2
Pin 3	COM	BLACK	16 AWG	Pin 3
Pin 4	COM	BLACK	16 AWG	Pin 4
Pin 5	+12V	BLACK	16 AWG	Pin 5
Pin 6	+12V	BLACK	16 AWG	Pin 6
Pin 7	+12V	BLACK	16 AWG	Pin 7
Pin 8	+12V	BLACK	16 AWG	Pin 8

P8&P11 P6-42002K21-B6 P2-42002K138-B OR EQU.	RATING	WIRE COLOR	WIRE AWG	P10&P13 P8-42002K12A-B2 OR EQU.
Pin 1	+12V	BLACK	16 AWG	Pin 1
Pin 2	+12V	BLACK	16 AWG	Pin 2
Pin 3	+12V	BLACK	16 AWG	Pin 3
Pin 4	COM	BLACK	16 AWG	Pin 4
Pin 5	COM	BLACK	16 AWG	Pin 5
Pin 6	COM	BLACK	16 AWG	Pin 6
Pin 7	COM	BLACK	16 AWG	Pin 7
Pin 8	COM	BLACK	16 AWG	Pin 8

P9&P12 P6-42002K21-B6 P2-42002K138-B OR EQU.	RATING	WIRE COLOR	WIRE AWG
Pin 1	+12V	BLACK	18 AWG
Pin 2	+12V	BLACK	18 AWG
Pin 3	+12V	BLACK	18 AWG
Pin 4	COM	BLACK	18 AWG
Pin 5	COM	BLACK	18 AWG
Pin 6	COM	BLACK	18 AWG
Pin 7	COM	BLACK	18 AWG
Pin 8	COM	BLACK	18 AWG

P14 P012-3000P54Z-B	RATING	WIRE COLOR	WIRE AWG	P15 P012-3000P54Z-B
Pin 1	+12V	BLACK	16 AWG	Pin 1
Pin 2	+12V	BLACK	16 AWG	Pin 2
Pin 3	+12V	BLACK	16 AWG	Pin 3
Pin 4	+12V	BLACK	16 AWG	Pin 4
Pin 5	+12V	BLACK	16 AWG	Pin 5
Pin 6	+12V	BLACK	16 AWG	Pin 6
Pin 7	COM	BLACK	16 AWG	Pin 7
Pin 8	COM	BLACK	16 AWG	Pin 8
Pin 9	COM	BLACK	16 AWG	Pin 9
Pin 10	COM	BLACK	16 AWG	Pin 10
Pin 11	COM	BLACK	16 AWG	Pin 11
Pin 12	COM	BLACK	16 AWG	Pin 12
Pin S1	CARD_PWR_STABLE	BLACK	24 AWG	Pin S1
Pin S2	CARD_CBL_PRES#	BLACK	24 AWG	Pin S2
Pin S3	SENSE0	BLACK	24 AWG	Pin S3
Pin S4	SENSE1	BLACK	24 AWG	Pin S4

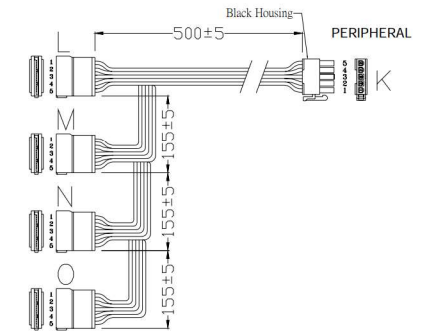
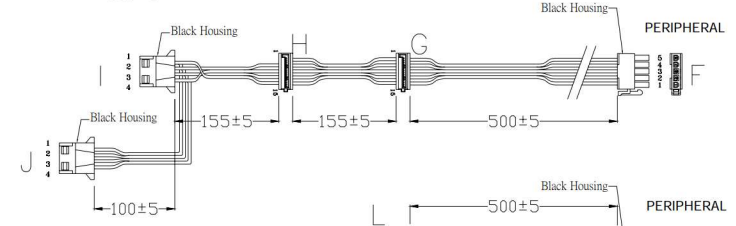
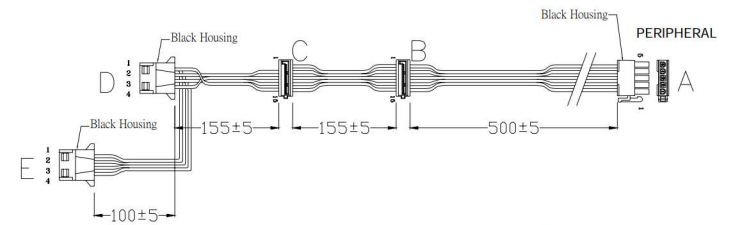

B&G P5-12702T00 OR EQU. P5-12702C OR EQU.	RATING	WIRE COLOR	WIRE AWG	A&F J2416V2-151A-0 OR EQUIV.
Pin 1	+3.3V	BLACK	18 AWG	Pin 5
Pin 2	COM	BLACK	18 AWG	Pin 4
Pin 3	+5V	BLACK	18 AWG	Pin 3
Pin 4	COM	BLACK	18 AWG	Pin 2
Pin 5	+12V	BLACK	18 AWG	Pin 1

L SD-67562-001 OR EQU.	RATING	WIRE COLOR	WIRE AWG	K J2416V2-151A-0 OR EQUIV.
Pin 1	+3.3V	BLACK	18 AWG	Pin 5
Pin 2	COM	BLACK	18 AWG	Pin 4
Pin 3	+5V	BLACK	18 AWG	Pin 3
Pin 4	COM	BLACK	18 AWG	Pin 2
Pin 5	+12V	BLACK	18 AWG	Pin 1

C&H P5-12702T00 OR EQU. P5-12702C1 OR EQU.	RATING	WIRE COLOR	WIRE AWG
Pin 1	+3.3V	BLACK	18 AWG
Pin 2	COM	BLACK	18 AWG
Pin 3	+5V	BLACK	18 AWG
Pin 4	COM	BLACK	18 AWG
Pin 5	+12V	BLACK	18 AWG

D&E&J 1-480424-0 OR EQU.	RATING	WIRE COLOR	WIRE AWG
Pin 1	+12V	BLACK	18 AWG
Pin 2	COM	BLACK	18 AWG
Pin 3	+5V	BLACK	18 AWG
Pin 4	COM	BLACK	18 AWG

UNIT:mm [inch]

MODEL NO. :FSP850-57AGC,(STD0001)

TITLE:ASSY

SHEET: 2 OF 2

REV:01

**P/N.:9PA8508500**