

REV	DATE	DESCRIPTION	DRAWN
2	FEB.05.2024	變更ECO開關方向&增加易碎貼紙	周書宇

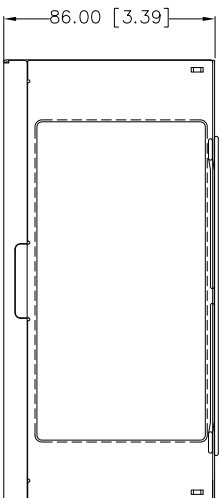
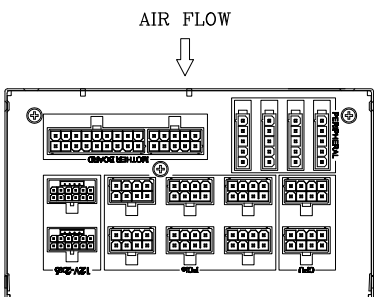
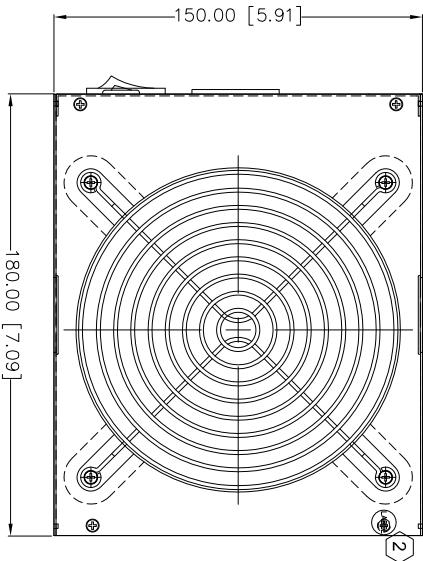
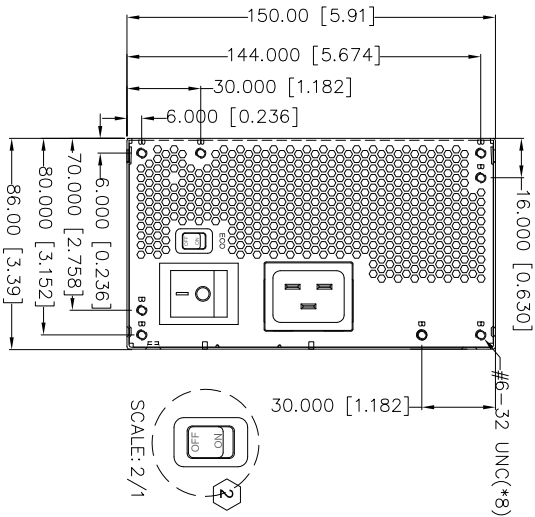

NOTE:

1. ALL THE LENGTH OF OUTPUT WIRES EXCLUDE HOUSING.
2. 公差: .XX=±0.5 [0.02]、.XXX=±0.25 [0.01]

UNIT:mm

P/N.:9PA16F0300

MODEL NO. : FSP1650-57ALB	TITLE: ASSY	SHEET: 1 OF 2	REV:02
R&D(2)	PE	DRAWN	DATE
INTERIOR COUNTERSIGN:			FEB.05.2024

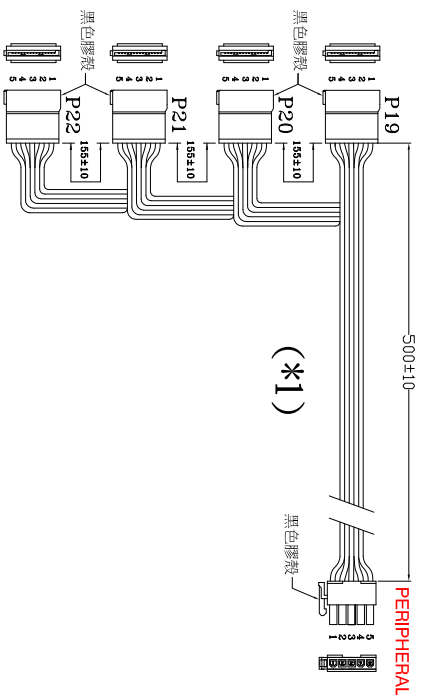
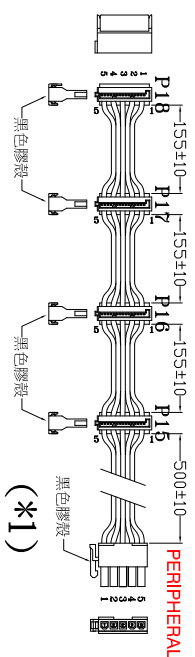
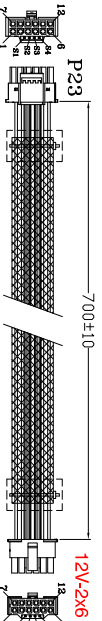
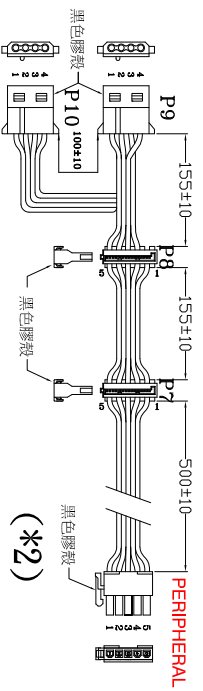
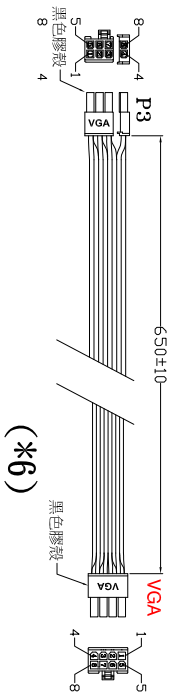
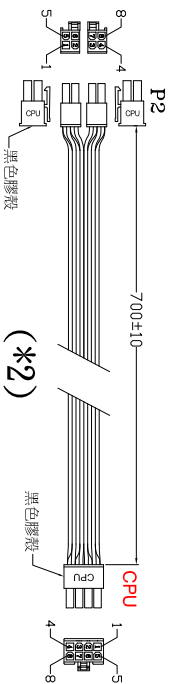
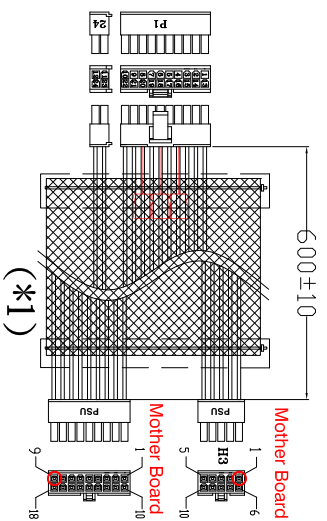

REF. ID.	PIN NO.	SIGNAL	WIRE COLOR	GAUGE	CONNECTOR TYPE
P7-8	1	+3.3VDC	BLACK	18	MOLEX SD-67926
	2	+5V	BLACK	18	-0011 or EQUIV.
	3	+5V	BLACK	18	
	4	COM	BLACK	18	
P15-18	5	+12V	BLACK	18	
	6	+12V	BLACK	18	
P9	1	+12V	BLACK	18	AMP 1-480424-9 or EQUIV.
	2	COM	BLACK	18	
	3	+5V	BLACK	18	
	4	+5V	BLACK	18	
P10	1	+3.3VDC	BLACK	18	MOLEX SD-67582
	2	COM	BLACK	18	-001 or EQUIV.
P22	1	+12V	BLACK	16	
	2	+12V	BLACK	16	
	3	+12V	BLACK	16	
	4	+12V	BLACK	16	
	5	+12V	BLACK	16	
	6	+12V	BLACK	16	
	7	COM	BLACK	16	
	8	COM	BLACK	16	
P23	9	COM	BLACK	16	WST PD12-130006FS4Z
	10	COM	BLACK	16	-B
	11	COM	BLACK	16	
	12	COM	BLACK	16	
	S1	CARD_PWK_STABLE	BLACK	24	
	S2	CARD_CK_PHSW	BLACK	24	
	S3	SENSFO	BLACK	24	
	S4	SENSB1	BLACK	24	

REF. ID.	PIN NO.	SIGNAL	WIRE COLOR	GAUGE	CONNECTOR TYPE
P1	1	+3.3VDC	BLACK	16	WST
	2	+3.3VDC	BLACK	16	P20-
	3	+3.3VDC	BLACK	22	142002K11D-B
	4	COM	BLACK	16	+ P4-
	5	+5V	BLACK	16	142002K11D-B or EQUIV.
	6	+5V	BLACK	16	
	7	COM	BLACK	16	
	8	PW-OK	BLACK	22	
	9	+5Vsb	BLACK	16	
	10	+12V	BLACK	16	
P2	11	+12V	BLACK	16	
	12	+3.3VDC	BLACK	16	
	13	+3.3VDC	BLACK	16	
	14	-12VDC	BLACK	16	
	15	COM	BLACK	16	
	16	PS-ON	BLACK	22	
	17	COM	BLACK	16	
	18	COM	BLACK	16	
	19	COM	BLACK	16	
	20				
P3	21	+5V	BLACK	16	
	22	+5V	BLACK	16	
	23	+5V	BLACK	16	
	24	COM	BLACK	16	
	1	COM	BLACK	16	WST
	2	COM	BLACK	16	P4-
	3	COM	BLACK	16	142002K3B-B4
	4	COM	BLACK	16	+ P4-
P2	5	+12V	BLACK	16	142002K4B-B4 or EQUIV.
	6	+12V	BLACK	16	
	7	+12V	BLACK	16	
	8	+12V	BLACK	16	
	1	+12V	BLACK	16	WST
	2	+12V	BLACK	16	P6-
	3	+12V	BLACK	16	142002K21-B6
	4	COM	BLACK	16	+P2-
P3	5	COM	BLACK	16	142002K13B-B or EQUIV.
	6	COM	BLACK	16	
	7	COM	BLACK	16	
	8	COM	BLACK	16	

P/N.:9PA16F0300

UNIT:mm [inch]

MODEL NO.: FSP1650-57ALB

TITLE: ASSY

SHEET: 2 OF 2 REV:02